











Safety instructions



Read the safety instructions before using the appliance and use it properly. The important instructions are included here in order to prevent danger and injury to the user. This takes the form of a step-by-step guide to dangers and injuries resulting from improper use.

 Statement on danger to life and serious injury.	 Statement on possibility of injury and damage to property.
The following symbols indicate the instructions which should be followed.	
 Indicates that this should not be carried out.	 Indicates that this should be carried out.

Warning

	• Avoid damage to power cable and plug. Damaged parts cause electric shock, short circuit and fire.
	• Using with wet hands: do not touch the plug with wet hands. This causes electric shock.
	• Remove dust regularly from the power cable. Dust combined with humidity causes damage to insulation and fire. • Insert the plug correctly. Incomplete contact causes electric shock or heat-induced fire. • Do not use damaged or loose plugs.
	• Do not place fabric or paper or other flammable materials over the appliance or use them to cover it. This causes fire.
	• Do not carry out any modifications or changes yourself. This causes fire or injury from electric shock.
	• Pull out the plug if you notice any irregularities. Then contact your dealer.

Note

	• Your appliance has a limited life span. Interior components may be damaged without this being obvious from the outside. Regular maintenance and care are recommended for this reason. Long-term use without maintenance / care can cause electric shock/fire. • Disconnect the appliance from the power supply for maintenance as otherwise there is a risk of electric shock.
	• Use in a wet environment: Do not use in a damp or humid atmosphere such as a bathroom or out of doors. This product is not waterproof.
	• Do not place appliances next to each other as this increases humidity. This can result in a shorter life for the appliance or cause fire. • Do not combine with a dimmer switch. This causes fire. • Do not lean against the appliance or knock into it. This causes electric damage. • Do not look directly into the LED. This causes pain in the eyes.

Instructions for use

- The recommended operating temperature is between 15°C and 30°C.
- Growth varies according to conditions. Green moss grows depending on conditions. This does not have an adverse effect. If you want to remove it, remove the plants from the culture tray and wash the irrigation tray with washing-up liquid.
- The rooting sponges may go yellow in sunlight but this does not impair their function.

Care and storage

- Switch off the appliance and remove the power cable. Now carefully remove the irrigation tray and the culture tray without spilling the contents.
- The remaining liquid can be disposed of via the normal waste pipe or can be used to water other plants.
- Rinse off the irrigation tray, culture tray and cover, using washing-up liquid for heavy soiling if necessary. Rinse and dry everything thoroughly to prevent rust and corrosion during storage.

Symptom	Possible cause	Solution
LED goes out during operation	Temporary loss of power or sudden drop in voltage	• Switch mains in "OFF" position. Check connection. • Turn on the appliance.
LED is not switched on.	Power cable is not connected.	• Switch the appliance off and then on again after waiting 3 seconds.

- If the problem persists switch the appliance off and consult your dealer.
- For questions concerning operation, care and repair first contact the dealer from whom you bought the appliance.

Warranty

This Akarina product is covered with an Olympia warranty for 12 months from the date of original purchase. If the product fails due to a manufacturing defect, please contact the seller immediately to launch a warranty claim.

Note: Proof of original purchase may be required to launch warranty claim.

- The following are excluded from Olympia's warranty coverage:
- *Devices purchased as 2nd hand or used items
 - *Devices purchased from unauthorized retailers or distributors
 - *Damage resulting from misuse and abusive action
 - *Damage resulting from chemical, fire, radioactive substance or poisonous liquid
 - *Damage resulting from a natural disaster
 - *Damage caused to any 3rd party/person/object

Note:

We're only able to provide after-sales services for purchases made directly from Olympia. If you purchased through a different retailer, please contact them for any exchange or refund requests.

*Please note that unauthorized reselling of Olympia products is prohibited.

CONTACT

Olympia Lighting Fixtures Industries, Ltd.
2-9-8, Honkomagome, Bunkyo City, Tokyo 113-0021, Japan
e-mail: sale@olympia-jp.co.jp web: www.olympia-jp.co.jp/world
(Own brands AKARINA / MotoM)
www.motom-jp.com/en

Akarina 01

Operating manual for Akarina
(Hydroculture system + LED)

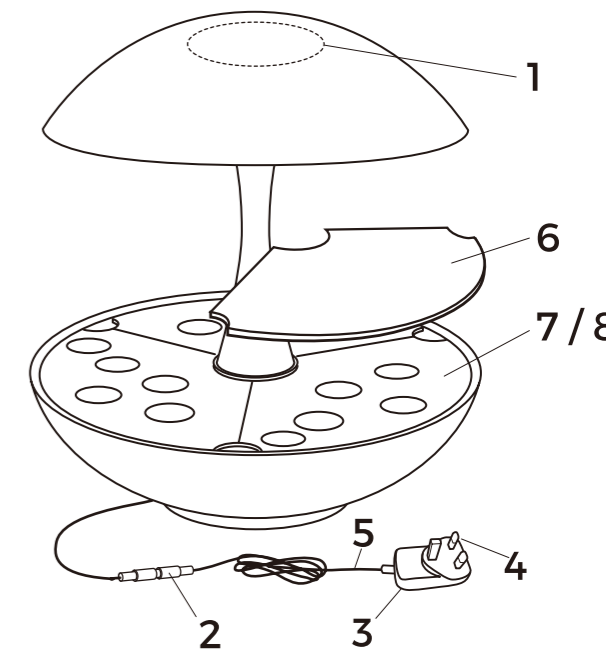

Name of component

1. Touch switch zone
2. Jack plug
3. AC adapter
4. Plug
5. Power cable
6. Cover
7. Culture tray
8. Irrigation tray

Note	dimensions	L 320 mm x W 320 mm x H 350 mm
Parts and accessories; make sure that you find the correct number of parts and accessories.	weight	2.1 kg *filled approx. 3.9 kg*
	input voltage	AC 100-240 V 50/60 Hz
	output voltage	DC 12 V 2 A
	power consumption	20 W
	Length of power cable	1.5 m

Content

- | | |
|-----------------------------------|---------------------|
| 1x main unit with integrated LEDs | 30x rooting sponges |
| 3x irrigation trays | 1x power supply |
| 3x irrigation tray covers | 1x operating manual |
| 3x culture trays | |
| 14x plastic closure caps | |

Please have ready

One large dish, watering can (or PET bottle)
Use the accessories; the main unit does not function alone.
Note: Use only tap water. Not mineral water, distilled water, purified water or any other liquid.

Control

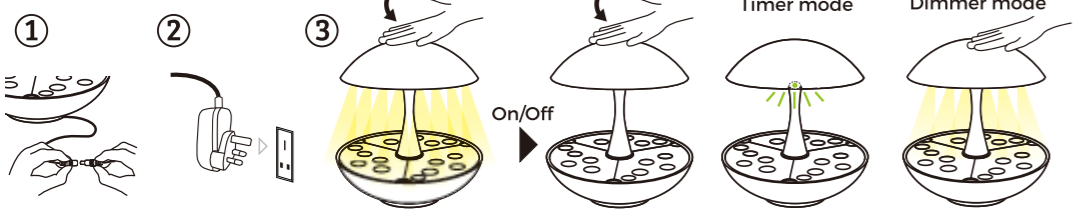

1. Connect the jack plug of AC adapter with the jack plug of main unit.
 2. Connect to the mains power supply at the socket. Check that the jack plug is securely connected to the jack socket.
- ⚠️ <Warning : Use the attached AC adapter. Non original adapter may damage the main unit or may cause heat-induced fire.>

3. LED Control

- 1) On/Off
Lightly touch the top of the shade once to switch on the LED light or to switch off. (The top shade zone where the touch sensor acts is within a 2 cm circle.)
- 2) Timer
Each time when the LED light is switched on by touching the top of the shade, the timer is automatically activated. This sets the time periods for the LED light to 16 hours ON and 8 hours OFF everyday. When the timer is in the 8 hour off phase, a small green lamp underneath the upper shade will be illuminated. When this small green lamp is lit, this shows the unit is in timer mode and therefore will switch on the main LEDs again after 8 hours have elapsed. To deactivate this timer function and switch the unit off completely, touch the top of the shade.
- 3) Dimmer
To activate the dimmer, keep on touching the top of the shade whilst the main LED light is switched on. As you continue to touch the top of the shade, the LED light level will gradually diminish from 100% to 1% then return back to 100% after the light level reaches 1%. When the main LED light reaches your preferred level, stop touching the shade. NOTE: Excessive use of the dimmer function will slow down plant growth rate. * If the main LED light has been turned off completely, both the timer and dimmer modes are cancelled.

Procedure

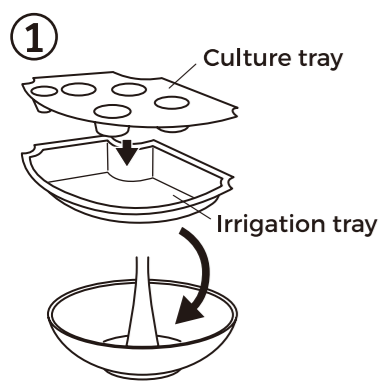

1. Place the irrigation tray and culture tray into the main unit
2. Make up the nutrient solution first and pour it into the irrigation tray (see below and diagram to left).
Dilute the resulting liquid fertilizer with water from watering can or PET bottle. Follow the specific instructions on the liquid nutrient packaging for correct dilution.
Place the culture tray on top of the irrigation tray then pour the prepared mixture into the refill hole of the culture tray so it fills the irrigation tray underneath up to the fill level marking.



3. Preparing the sponge cubes
Separate the sponge cubes at the perforations
Submerge the sponge in a large bowl of water. Press each sponge four or five times under water to expel the air. The rooting sponges may go yellow in sunlight but this does not impair their function.

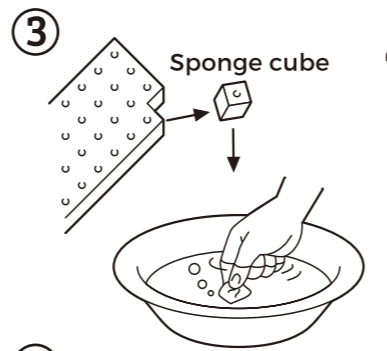

4. Insert the rooting sponges
Place the water-filled rooting sponges into the holes in the culture tray (indented side uppermost).
Select the spacing between the sponges according to the seed-type. The upper surface of the sponge cube should be level with the culture tray. If the sponge cube is not inserted deeply enough it can not absorb the feed and the seed will not germinate. Do not place sponges into the water metering hole. Cover any unused holes with a closure cap.

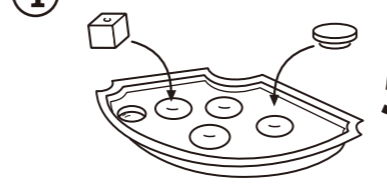

5. Seeding
Place the seed in the centre of the indentation in the sponge cube.

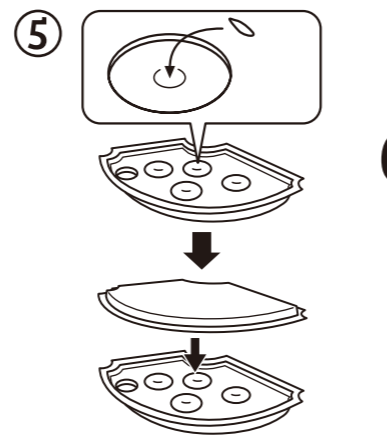

6. Monitor the seeds
After the seeds have been planted they should be checked daily. Remove the cover when the seeds have split and small pale green leaves have appeared. The germination time varies depending on the type of seed and the temperature.
Connect the jack plug to the main unit and plug the power cable into the wall socket.

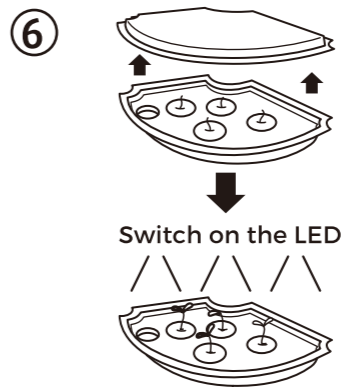

7. Use as a table lamp
The lower section can be removed and used as a table lamp. Remove lower section cable from hole. Loosen screws.

7. Growth and harvesting
If the leaves are growing too close together make more room for them by removing an entire neighbouring cube or by harvesting the product.
Two harvesting methods: Remove the whole plant as soon as it is the required size.
Harvesting the leaves: Remove the fullygrown leaves, leaving the shoots in the centre.
If no new shoots grow, harvest the whole plant and start a fresh batch.

- Sowing tips**
- Sow 1 or 2 seeds per sponge. Too many seeds interfere with growth.
 - Too little water in the sponge cube inhibits germination. Grow only one type of seed in each pot. Mixed seeds inhibit germination.
 - Leaving the cover off encourages the growth of moss.
 - Each plant requires its own ideal temperature for germination. In principle most plants germinate at around 20°C.
 - Check the germination temperature given on the seed packet.
 - Mop up any spilled or dripped nutrient solution or water immediately as it can cause rust or corrosion.

